

Dimensional Drawings Dual Foam Tank Selector Kit

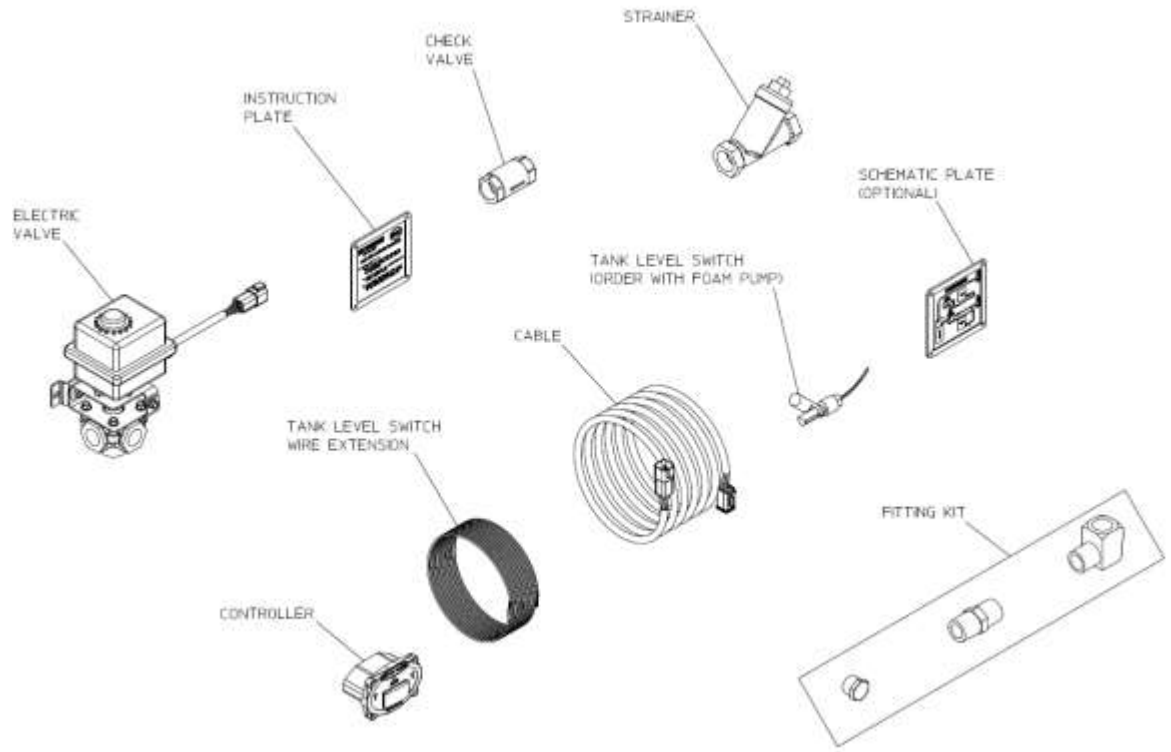

| Components: | Page |
|--------------------------------------|-------------|
| Electric Valve..... | 2 |
| Controller | 2 |
| Cable | 2 |
| Panel Plates | 3 |
| Strainer | 3 |
| Fitting Kit..... | 3 |
| Cable Extensions | 3 |
| Optional Hose and Fitting Kits | 4, 5 |

Schematics:

Plumbing:

| | |
|--|---|
| Dual Tanks Used | 4 |
| One Tank and Overboard Pick-up Used..... | 5 |

Electrical:

| | |
|--|---|
| Dual Tanks Used | 6 |
| One Tank and Overboard Pick-up Used..... | 7 |

Tank Level Switches:

Order with Foam Pump, See Foam Pump Dimensional Drawings

Overboard Foam Pick-up

See Dimensional Drawing DPL83493

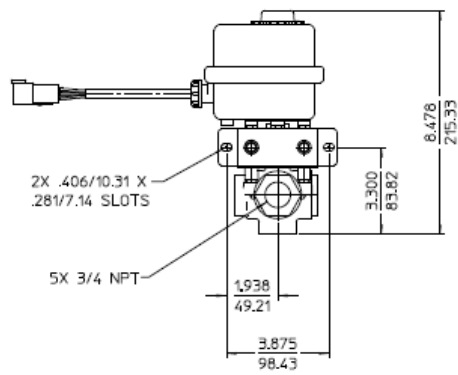
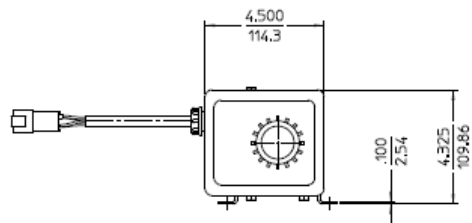

ELECTRIC VALVE

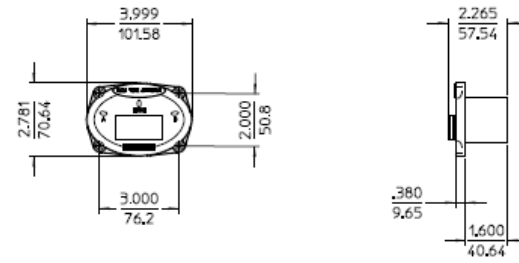
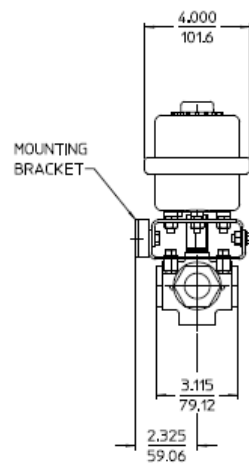

CONTROLLER

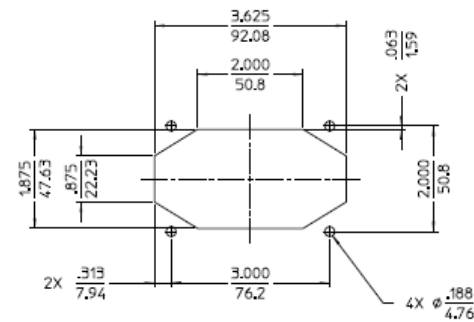

PANEL CUT-OUT

ALL DIMENSIONS SHOWN AS INCH/MILLIMETER
 (INCH / MILLIMETER)

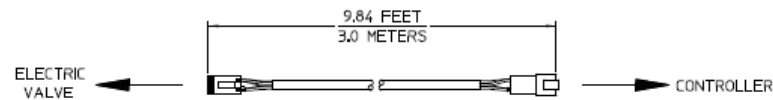

CONTROLLER TO ELECTRIC VALVE CABLE

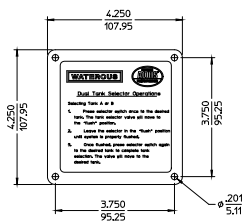

INSTRUCTION PLATE
(1) FURNISHED

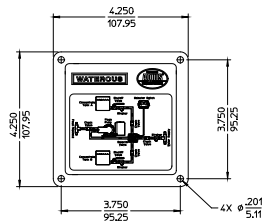

ORDER PART NO. 63833

SCHEMATIC PLATE
(OPTIONAL)

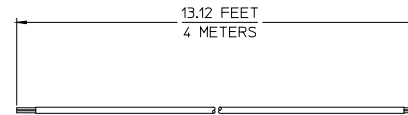

TANK LEVEL SWITCH WIRE EXTENSION
(2) FURNISHED

PANEL PLATES

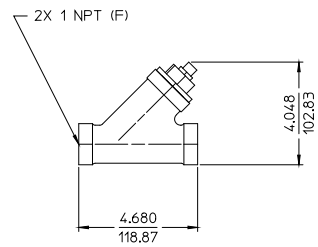

STRAINER
(3) FURNISHED

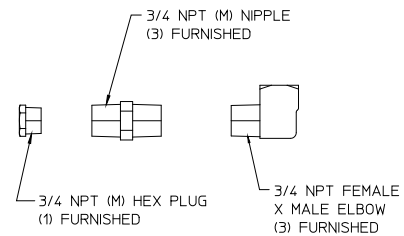

FITTING KIT

ALL DIMENSIONS SHOWN AS INCH/MILLIMETER
($\frac{\text{INCH}}{\text{MILLIMETER}}$)

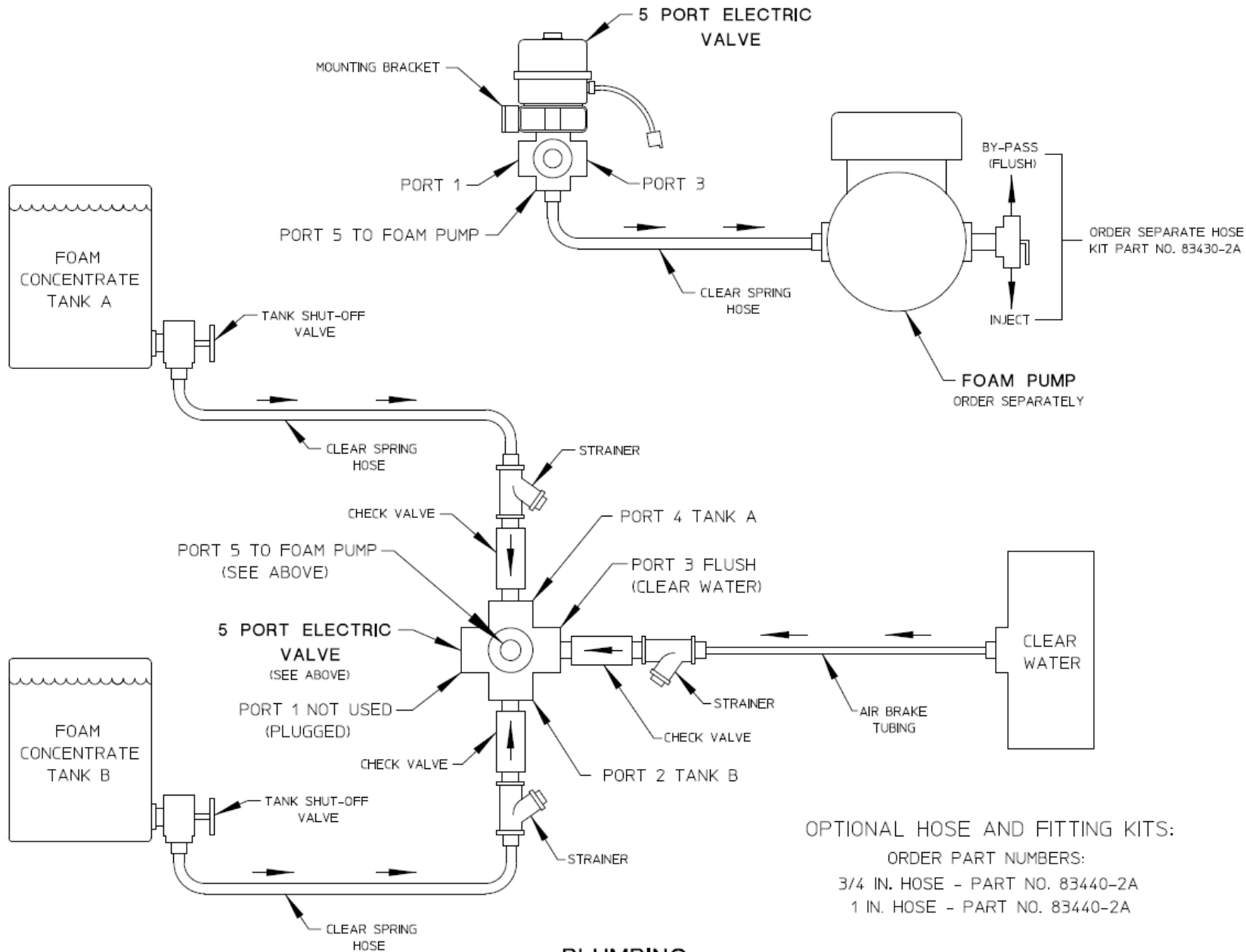

OPTIONAL HOSE AND FITTING KITS:
 ORDER PART NUMBERS:
 3/4 IN. HOSE - PART NO. 83440-2A
 1 IN. HOSE - PART NO. 83440-2A

**PLUMBING
 DUAL TANKS USED**

IL4184

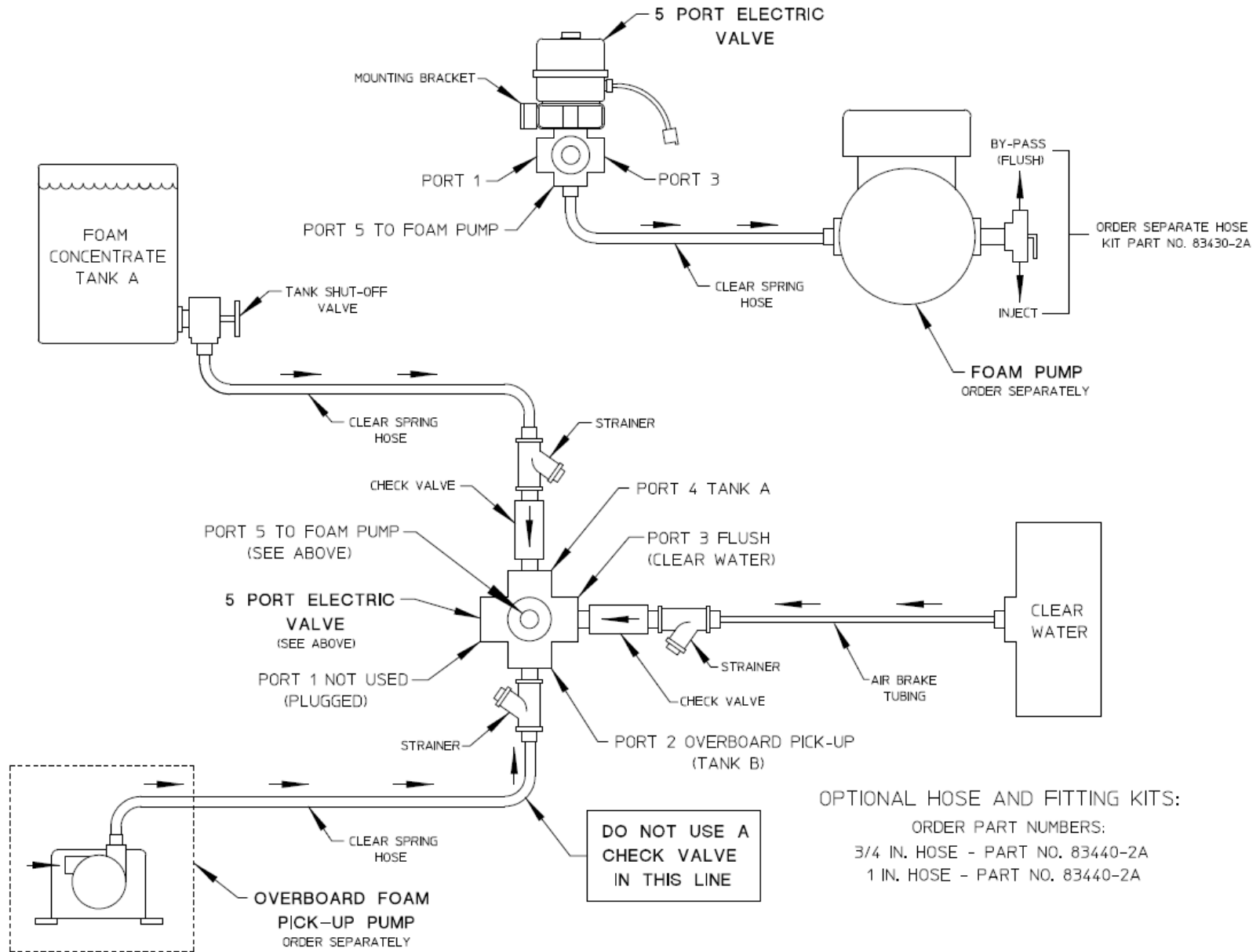

PLUMBING
ONE TANK AND OVERBOARD PICK-UP CONFIGURATION

IL4185

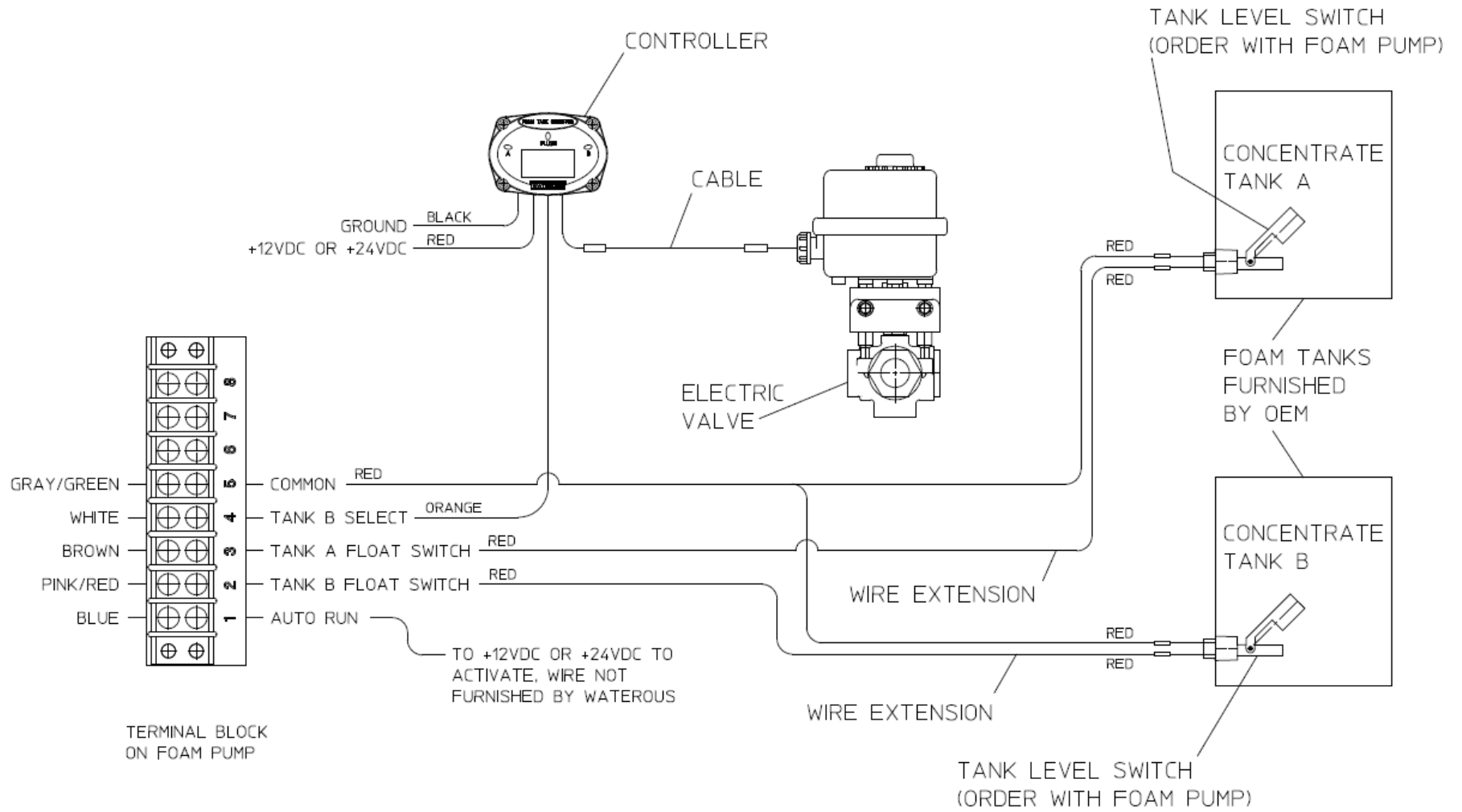

SCHEMATIC - ELECTRICAL
WITH DUAL TANKS

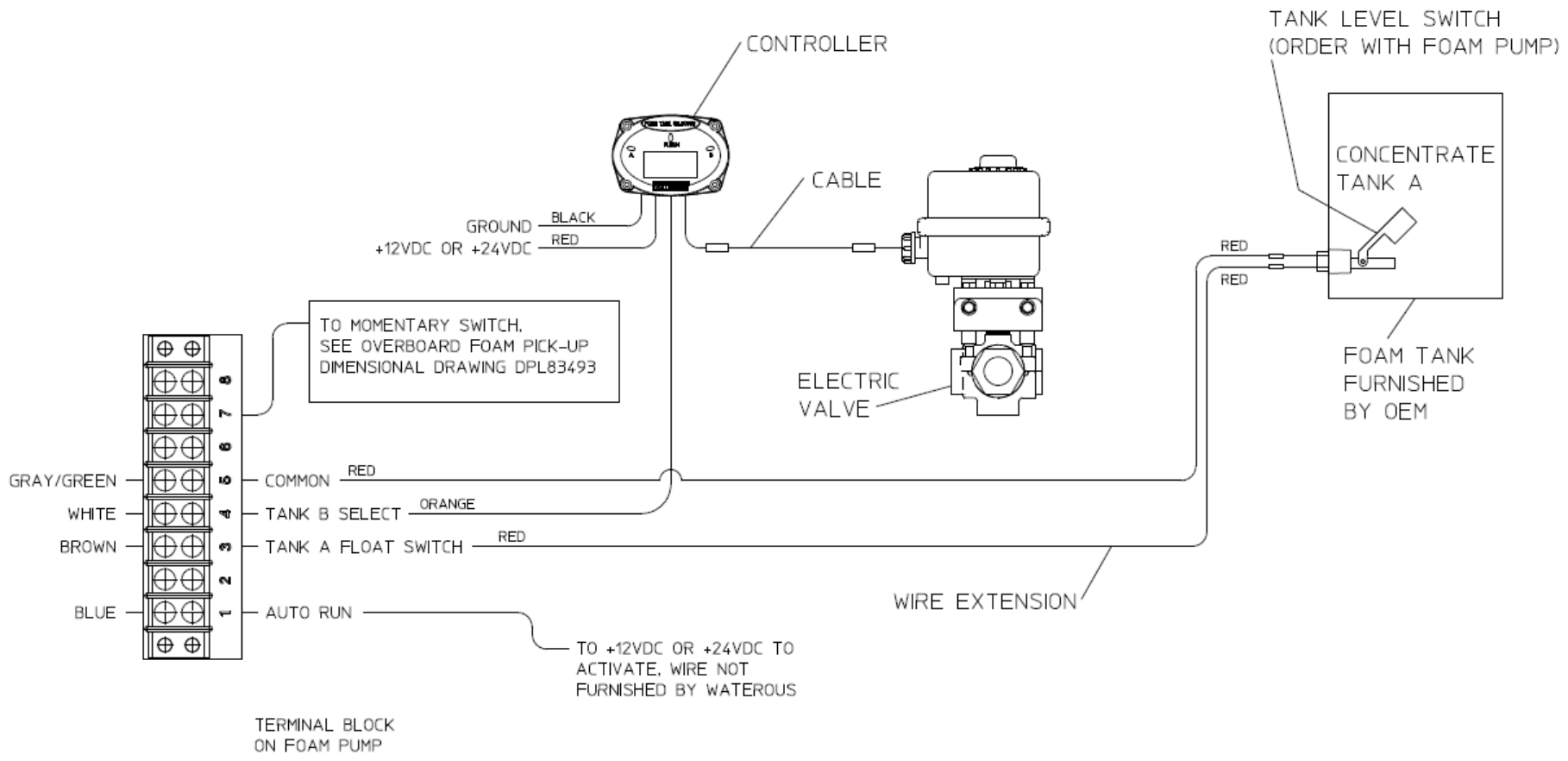

SCHEMATIC - ELECTRICAL
WITH ONE TANK AND
OVERBOARD FOAM PICK-UP