



Document Number	Issue Date	Rev. Date
DPL82908	07/01/09	7/7/15

VAP (Vacuum Activated) Priming Valve Dimensional Drawing

Index:

Pump		See Page		
Model	Material	Valve Mounting		Valve Dimensions
		On the Pump <i>(By Waterous)</i>	By the OEM <i>(Shipped Loose by Waterous)</i>	
CM, CMU, CMH, CMUH CS, CSU, CSH, CSUH	Iron	2	-	6
	Bronze	3		
CGVG	Iron or Bronze	4		
CLS	Iron or Bronze	5		
CXS	Iron or Bronze			
CGV, CGVN, CGVR	Iron or Bronze	-	7	-
CLV, CLR				
CXN, CXR, CXV				
CP-2				
CP-3				
CP-4				
CH-4				
CR				
CZ, CZU				
S100				

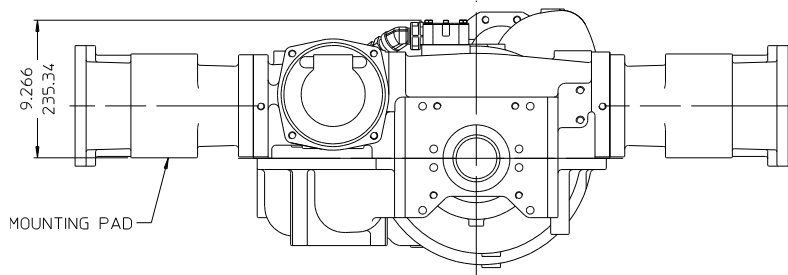
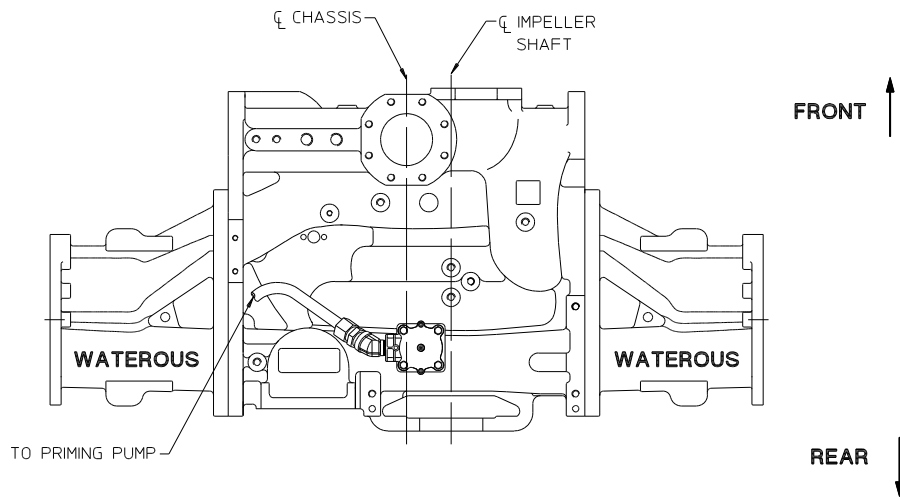

ALL DIMENSIONS SHOWN AS INCH/MILLIMETER
 (INCH / MILLIMETER)

IRON CM, CMU, CMH, CMUH MODELS

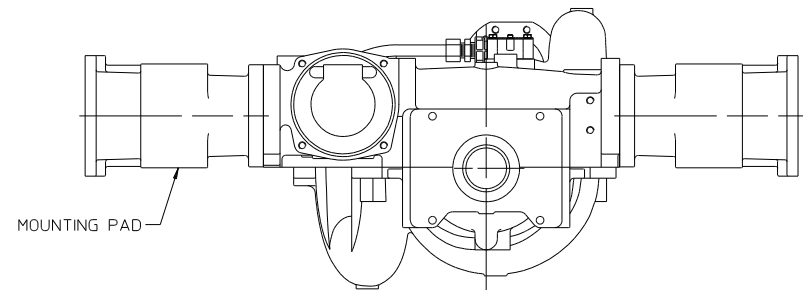
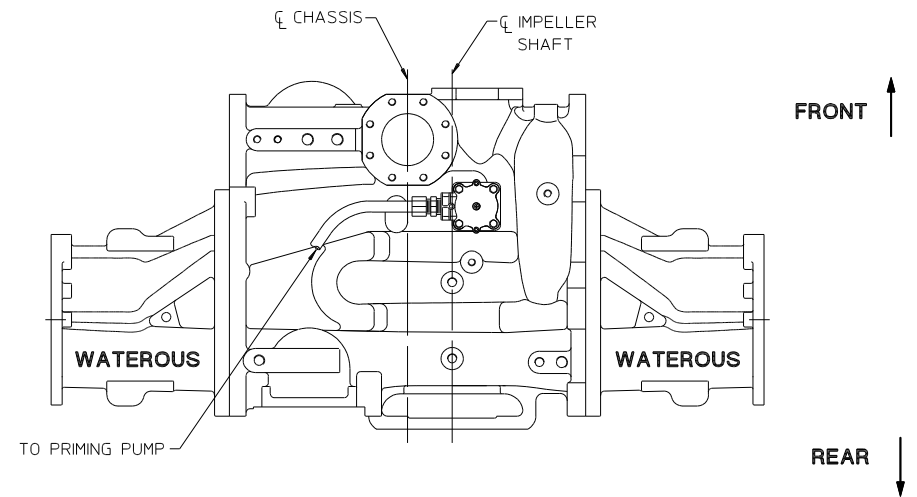

IRON CS, CSU, CSH, CSUH MODELS

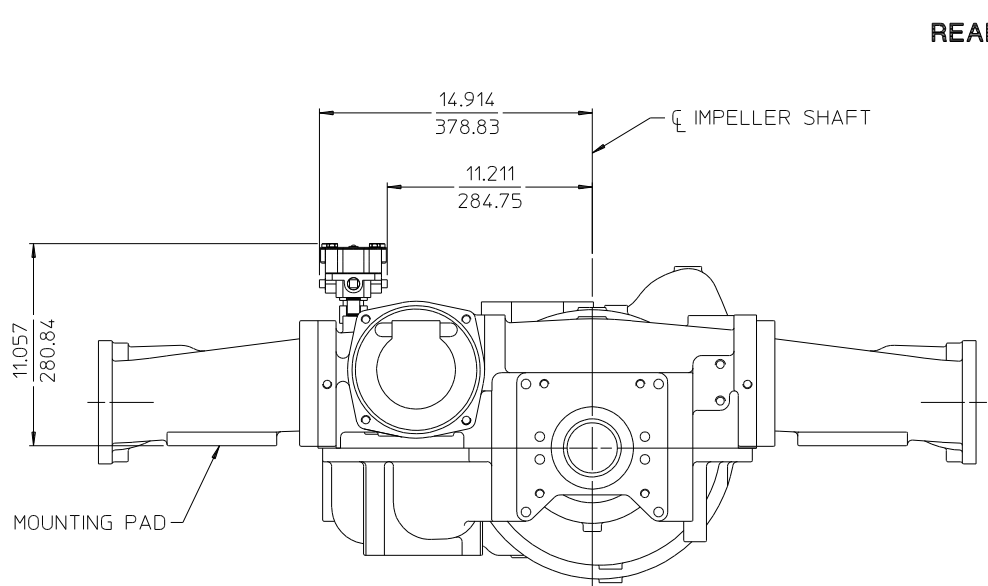
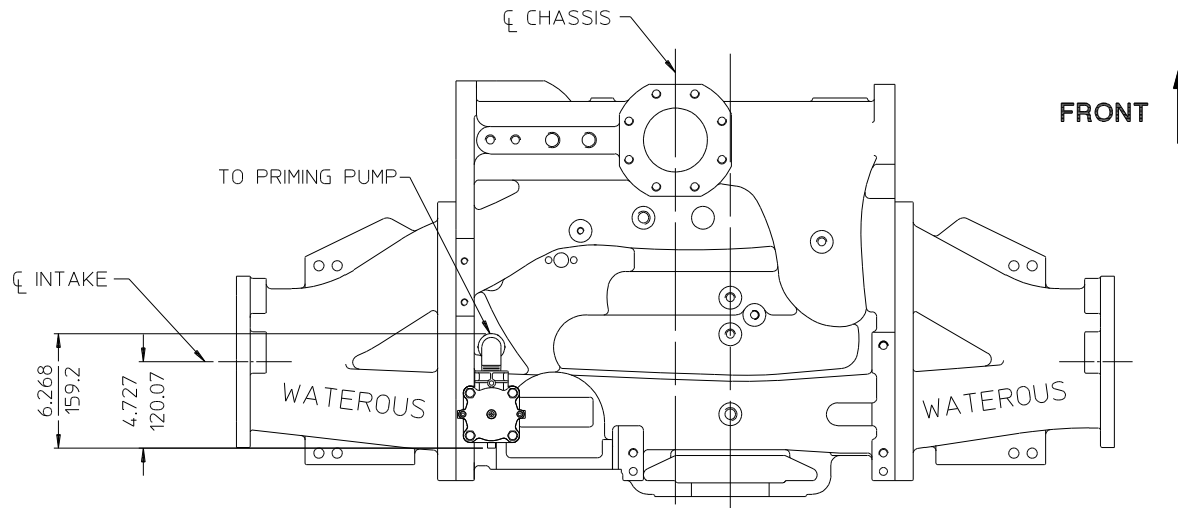

ALL DIMENSIONS SHOWN AS INCH/MILLIMETER
 ($\frac{\text{INCH}}{\text{MILLIMETER}}$)

BRONZE CM, CMU, CMH, CMUH MODELS
AND
BRONZE CS, CSU, CSH, CSUH MODELS
 (CM SHOWN)

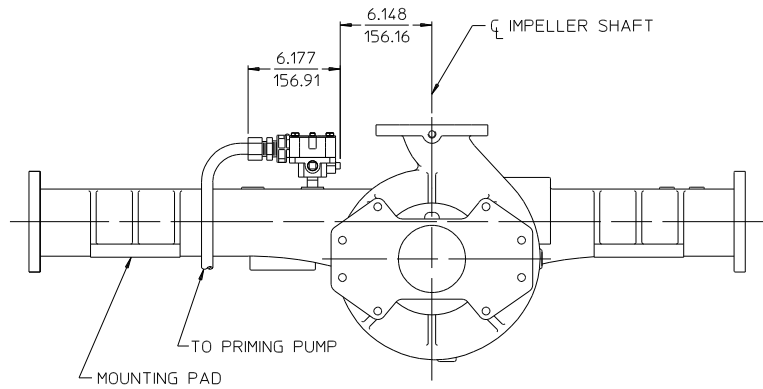
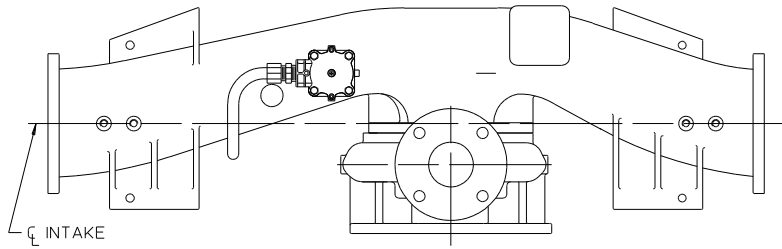

MODEL CGVG PUMP

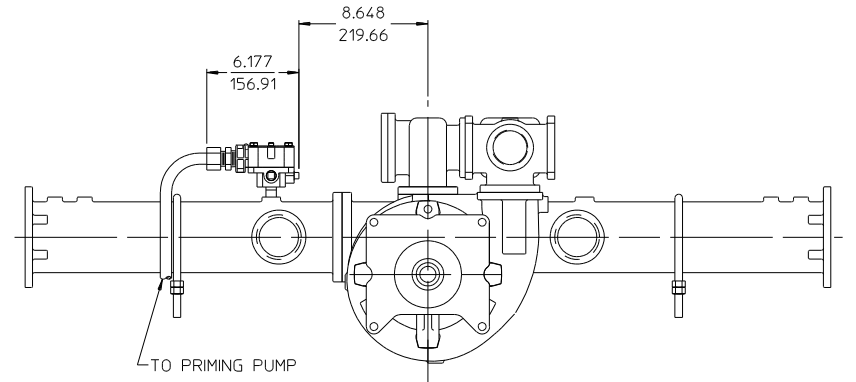
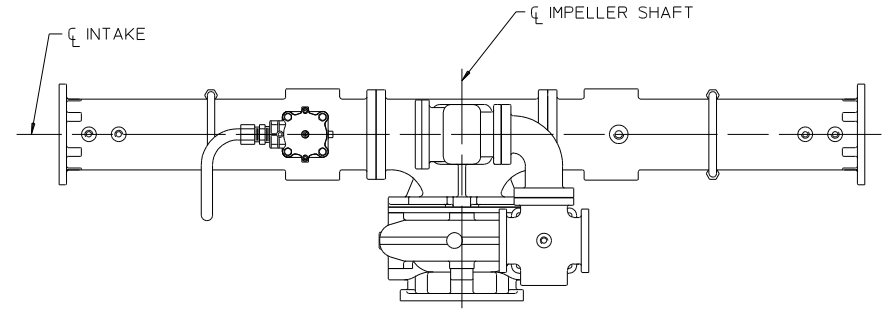

MODEL CLS PUMP

ALL DIMENSIONS SHOWN AS INCH/MILLIMETER
 INCH
 (MILLIMETER)

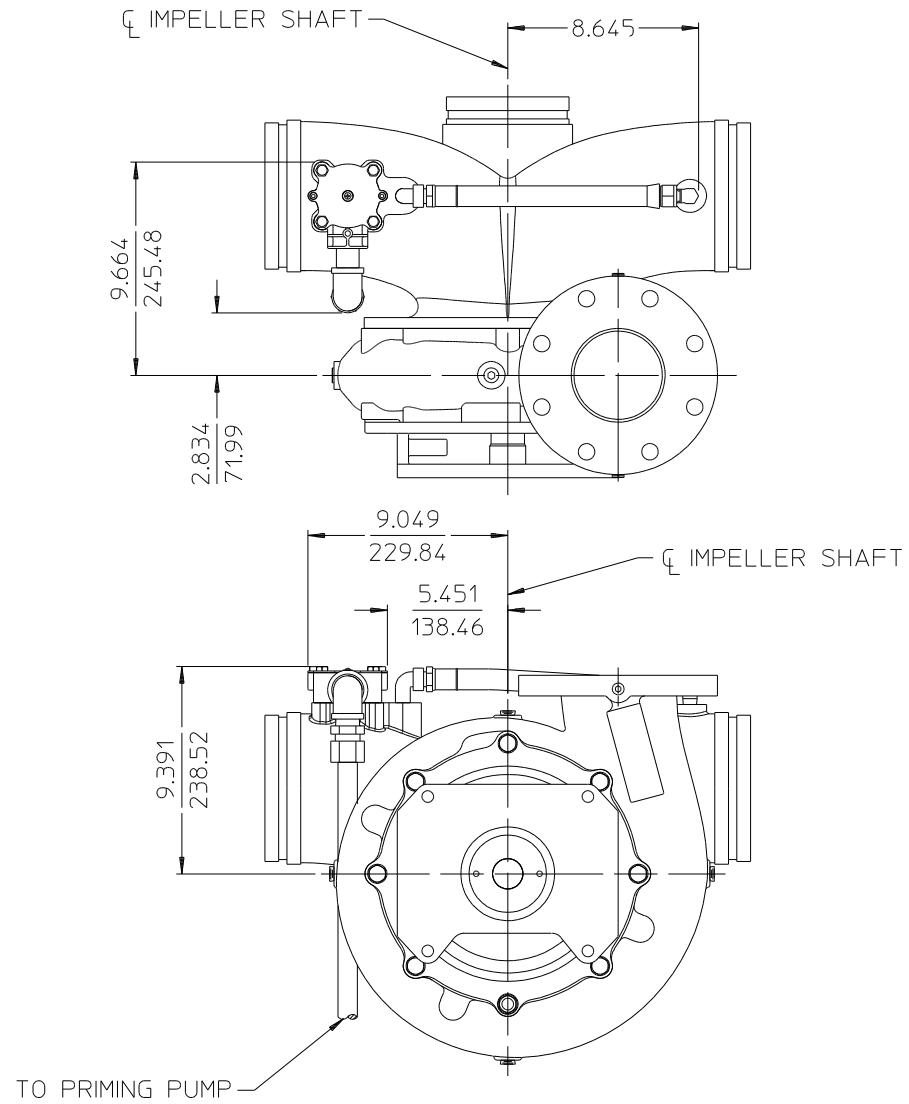

MODEL CXS PUMP

ALL DIMENSIONS SHOWN AS INCH/MILLIMETER

($\frac{\text{INCH}}{\text{MILLIMETER}}$)

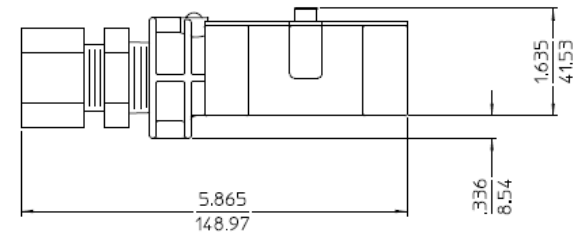
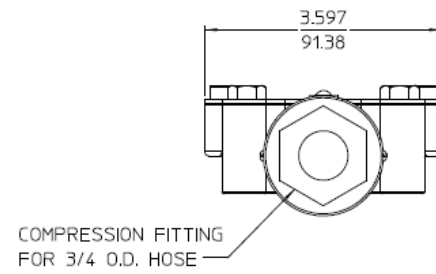
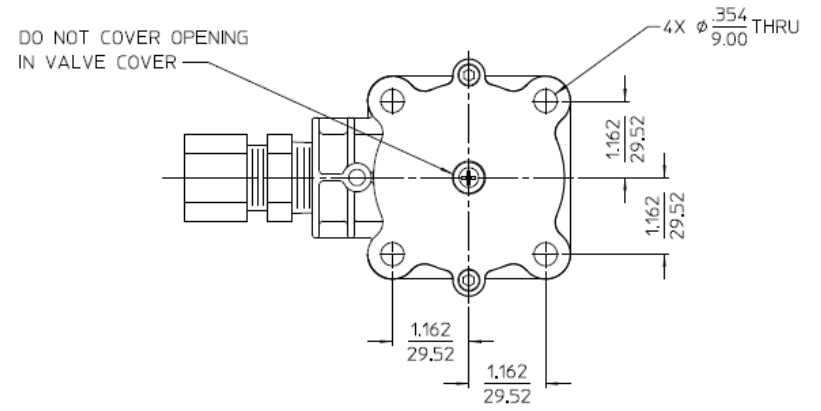

ALL DIMENSIONS SHOWN AS INCH/MILLIMETER

($\frac{\text{INCH}}{\text{MILLIMETER}}$)

DIMENSIONS OF PUMP MOUNTED VALVES

(MOUNTED BY WATEROUS)

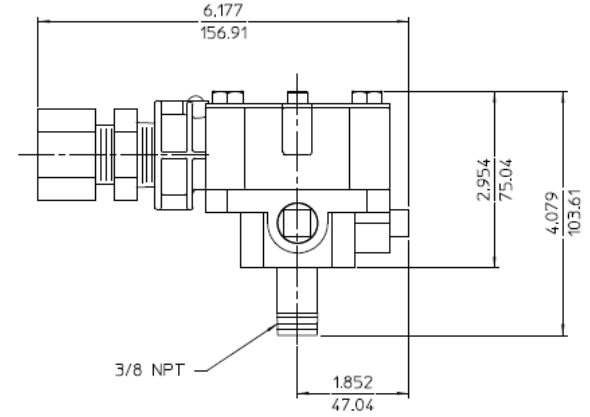
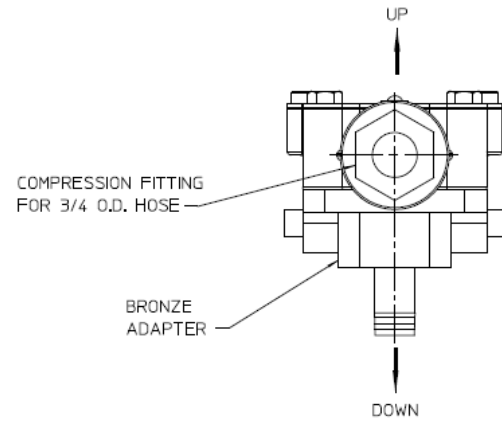
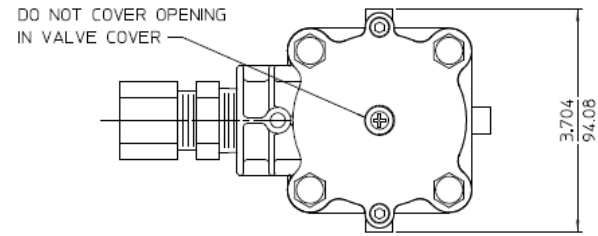

NOTE:

1. VAP PRIMING VALVE MUST BE MOUNTED IN A LEVEL POSITION WITH BRONZE ADAPTER FACING DOWN TO PREVENT WATER FROM BEING TRAPPED IN THE VALVE.

ALL DIMENSIONS SHOWN AS INCH/MILLIMETER

($\frac{\text{INCH}}{\text{MILLIMETER}}$)

VALVES MOUNTED BY THE OEM

(SHIPPED LOOSE BY WATEROUS)